



UNISEVEN  
ENGINEERING & INFRASTRUCTURE  
PRIVATE LIMITED



**Uniseven Engineering and  
Infrastructure Pvt. Ltd.**

Joint Ventures

Wholly owned  
subsidiary

**Narendra & Narendra  
(Engineers) Pvt. Ltd.**

**Beroa-Uniseven Refractory  
Services Pvt. Ltd.**

**Hidro-Uni Water Solutions  
Pvt. Ltd.**

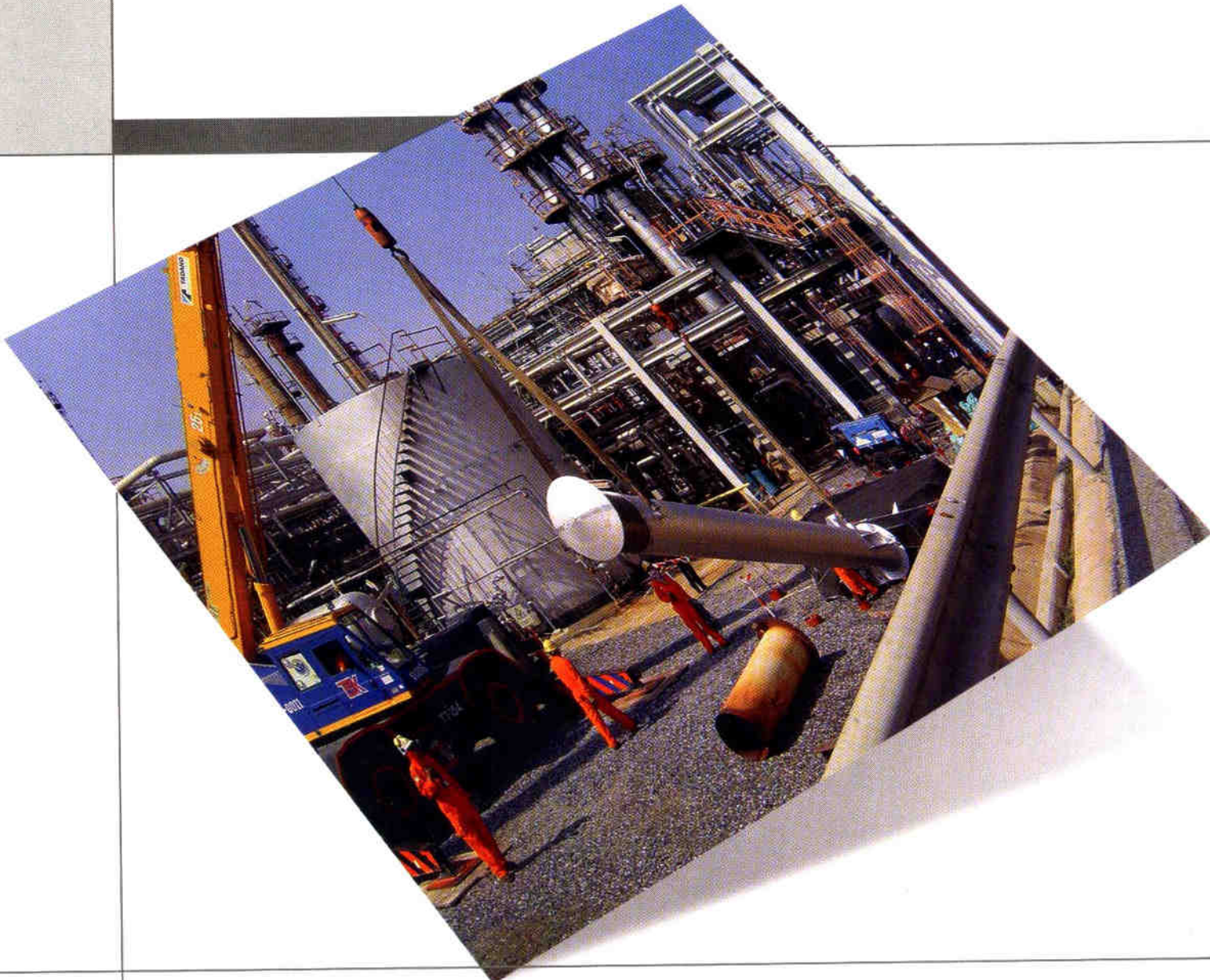



**7 Uniseven Engineering and Infrastructure Pvt. Ltd.** – Turnkey projects, engineering, manufacturing, supply, erection and O&M services.

**N Narendra & Narendra (Engineers) Pvt. Ltd.** – Engineering and manufacturing of equipment and components for core sectors.

**Beroa-Uniseven Refractory Services Pvt. Ltd.** – Engineering, supply, installation and maintenance solutions for all types of refractory applications. Joint venture with Beroa Technology Group, Germany.

**hidro-uni Hidro-Uni Water Solutions Pvt. Ltd.** – Hi-tech water, waste water treatment and recycling solutions. Joint venture with Hidroambiente, Spain.

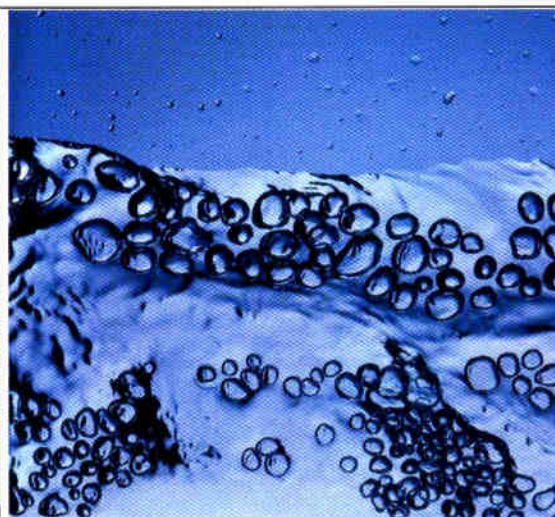
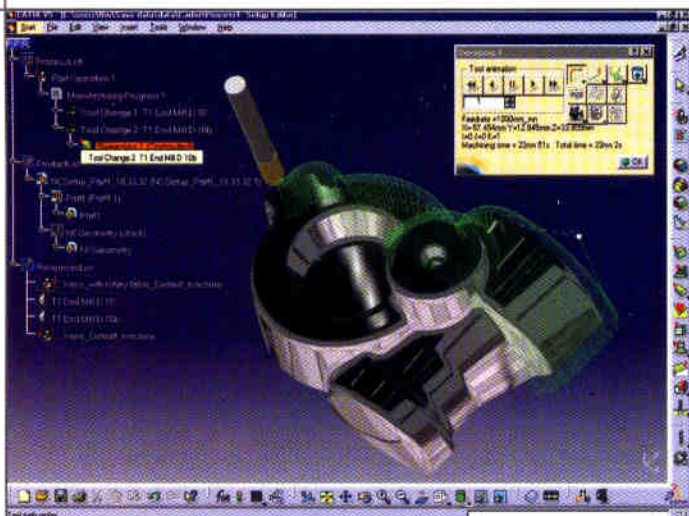



## 7

### Uniseven Engineering and Infrastructure Pvt. Ltd.

An Engineering, Procurement and Construction company with in-house manufacturing facilities possessing a successful track record of completing high-end engineering projects, primarily in the metallurgical and power sectors, in challenging environments.

- In-house design and engineering facilities
- Own manufacturing facilities
- Modern project monitoring system
- Safety and quality management system
- Team of qualified and experienced engineers and supervisors
- Bank of construction equipment
- O&M capability



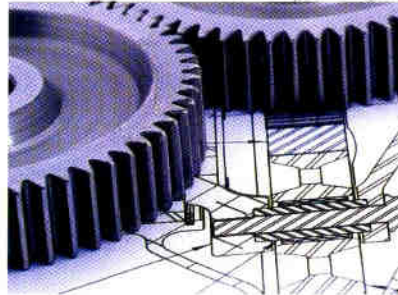
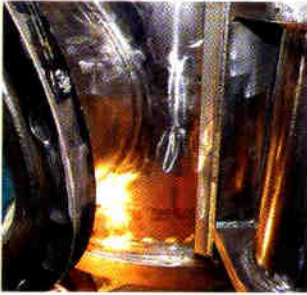
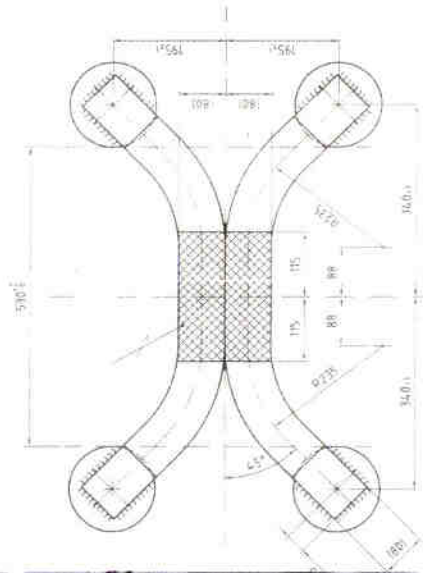

## Narendra & Narendra (Engineers) Pvt. Ltd.

A wholly-owned engineering and manufacturing subsidiary of Uniseven Engineering and Infrastructure Pvt. Ltd. that caters to requirements of mechanical equipment and components for core sectors.

- Over 40 years of operations
- Strategically located
- Supplier of import-substitution items to major steel producers
- Strong quality-assurance system

## Products & Services

- Large hydraulic / pneumatic cylinders
- Specialised conveying equipment
- High quality fabrication using MIG / TIG welding
- Components for coke oven machines
- Impellers for large fans
- Anode yokes, collector bars, pallets, stub pins, casting moulds, cooling jackets for aluminium smelters and cast-houses
- Refurbishing of rolling mills and other heavy equipment
- Customised parts of major capital equipment for core sector industries

**NARENDRA & NARENDRA  
(ENGINEERS) PVT. LTD.**

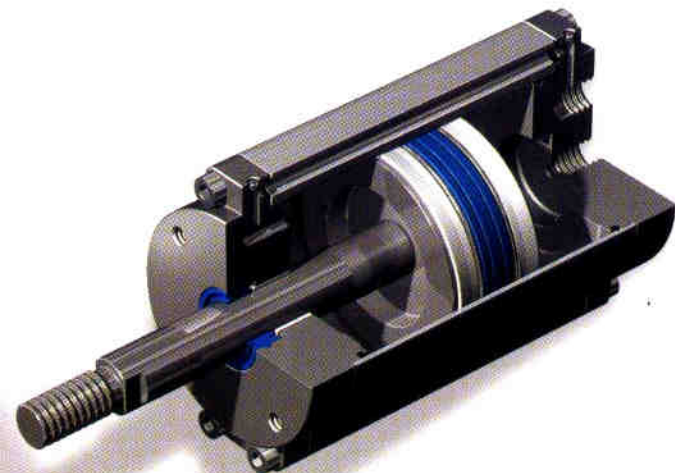



## Beroa-Uniseven Refractory Services Pvt. Ltd.

Joint venture with Beroa Technology Group (formerly Karrena), Germany, a global leader in engineering and installation of refractory materials that offers a complete range of refractory solutions – engineering, supply, installation and maintenance for metallurgical, cement, power and petrochemical sectors.

- Expertise of Beroa, a 75-year old company with presence across 40 countries with over 4,000 skilled personnel
- Bank of specialized equipment – shotcreting pumps, compressors, ceramic welding machines, specialized mixers, etc.
- Capacity and expertise for serving clients in any location across the world
- Safety compliance, quality assurance and timely execution

### Services

- Design and engineering
- Custom fabrication and supply
- Refractory dismantling, installation and maintenance / refractory lining installation and supervision
- Global servicing





## Hidro-Uni Water Solutions Pvt. Ltd.

Joint venture with Hidromambiente, part of Spanish conglomerate Ecnor, global leader in high-technology water engineering; provides integrated water and waste water management for industry as well as community.

### Services

- Technology, design and engineering
- Manufacture, assembly, supply, erection and commissioning
- Operation and maintenance
- Technical assistance and revalorization of existing plants
- Tailor-made solutions for critical problems for process industry

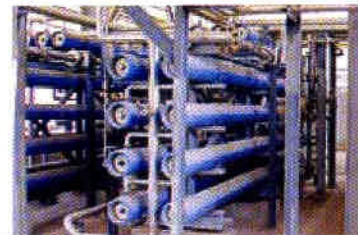

HIDRO-UNI WATER SOLUTIONS PVT. LTD.

### Technologies

- Clarifiers and dosing systems
- Filters
- Membrane-based solutions for brackish, sea and waste water
- Ion exchangers
- Biological reactors
- Decanters and thickeners
- Flotation systems for oil removal
- Electro de-ionisation
- Electro reversible distillation
- Sludge treatment

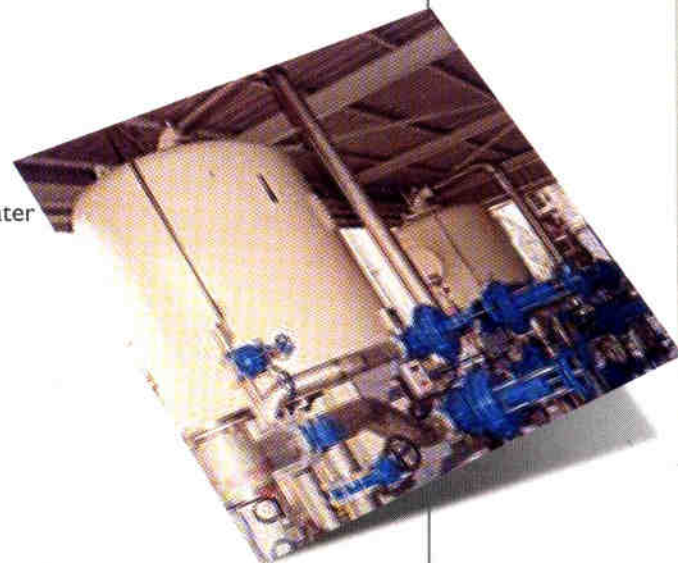



**UNISEVEN**  
**ENGINEERING & INFRASTRUCTURE**  
PRIVATE LIMITED

**Registered Office :**

30 D Jawaharlal Nehru Road, Kolkata - 700 016, India

Tel : +91 33 4002 9300, Fax : +91 33 4002 9310

E-mail : [info@uniseven.in](mailto:info@uniseven.in)

Video conferencing : 220.225.90.28

**Head Office :**

'ECOSPACE' Unit No. 401A

11F/11 New Town, Rajarhat

North 24 Parganas, Kolkata, West Bengal - 700156, India

**Branch Offices :**

Ahmedabad: +91 98980 53635

Bengaluru: +91 98450 54452

Chennai: +91 98842 31103

Mumbai: +91 98335 52208

New Delhi: +91 98994 50111

[www.uniseven.in](http://www.uniseven.in)